

PRODUCT DESCRIPTION

- Fixed output build in LED Driver.
- Constant Current LED Driver.
- Nominal Life-Time Upto 30,000 hr.
- 3/5 Year Warranty.
- High Voltage withstanding capacity 440V AC.
- CE (Certified)
- IS 15885 (Part 2/Sec 13).
- IS 16104.
- IEC 60950-1.
- IEC 61000-4-5.



Input Characteristics

1	Voltage (Un)	240 Vac
2	Operating Voltage Range	100 ~300 Vac
3	Frequency (Hz)	50 / 60 Hz
4	Maximum Input Current	0.08A
5	Input Power (W)	20W
6	Power Factor (PF)	> 0.98
7	Inrush current Protection	Yes
8	Current Harmonics (Athd)	< 10%
9	Surge Withstanding Capacity	4KV
10	Over Voltage Cutoff	320V (Tole - +/-10V)
11	Under Voltage Cutoff	90V (Tole - +/-10V)
12	Automatic Restart	300V
13	Driver Life	>30000Hrs

Output Characteristics

Output short circuit protection and Restart	Yes
Thermal Protection	Yes
No-Load Protection	Yes
Max Output Current	Yes
Max Output Current	300mA (Tole - +/-3%)
Output Voltage	60V
Output Power (W)	18W max
Efficiency	88%

Environmental Operating Details

1	Minimum Starting Temperature	-30°C ... 75°C
2	Max. Ambient Temperature	-30°C ... to 50°C
3	Max. Case temperature (Tc)	75°C

Key Features

- Compact Design
- High Voltage withstanding capacity
- High Surge withstanding capacity
- Long Life
- High Durability
- IP65
- Automatic Restart after Safe Voltage Mode.

PLASTIC BOX

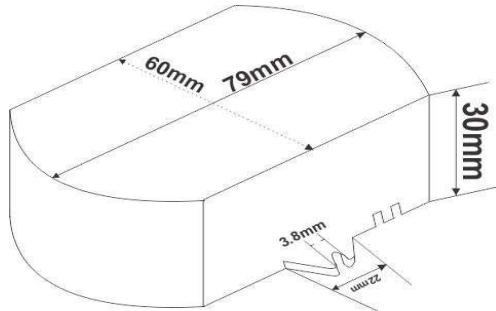

Mechanical Details

1	Weight	250gm
2	Case Dimensions	
	Length W/Mount	80mm
	Center to Center (CTC)	71mm
	Width	60mm
	Height	33mm
3	Case Material	PC
4	Wiring Diagram	On Screen
5	Input / Output Terminals	Wire
6	Wires Length & Colors	300mm
	Input (Yellow)	Yes
	Output (Red & Black)	Yes
7	Potting	Yes IP-65

BOTTOM

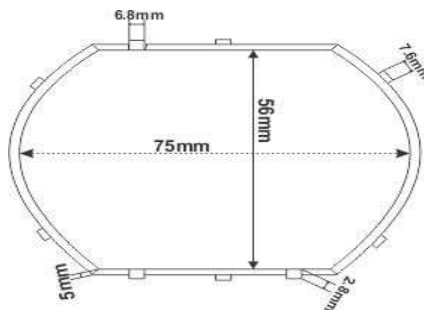

TOP

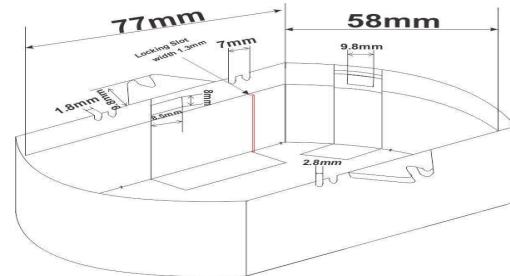

Sr./Gat No.08,A/P ,Sasewadi ,Tal.Bhor ,Dist Pune ,Near ZP School ,Sasewadi ,Pune 412205.Maharashtra (India)

Email ID :- marketing@hrindustry.net ,hrindustry12@outlook.com. Mobile :- 9049378851